

TS Tastensatz  
 PW Potiwinkel  
 KW Kühlwanne  
 LP Leiterplatte

✓ Pegelplan  
 L - Regler auf  
 HJT-Regler in Linearstellung  
 B - Regler in Mittenstellung

\*\* Q1 - Eingang  
 Expartausf.  
 Inlandausf.  
 siehe Zeichng  
 Nr. 187 - 1.3

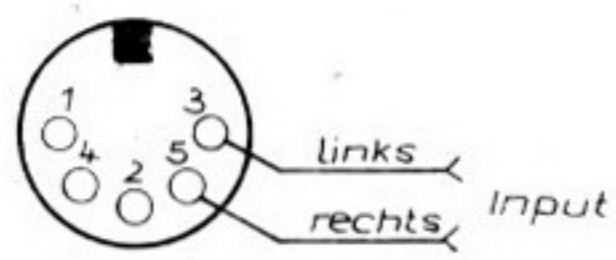

\*\*\* 7... 12 K

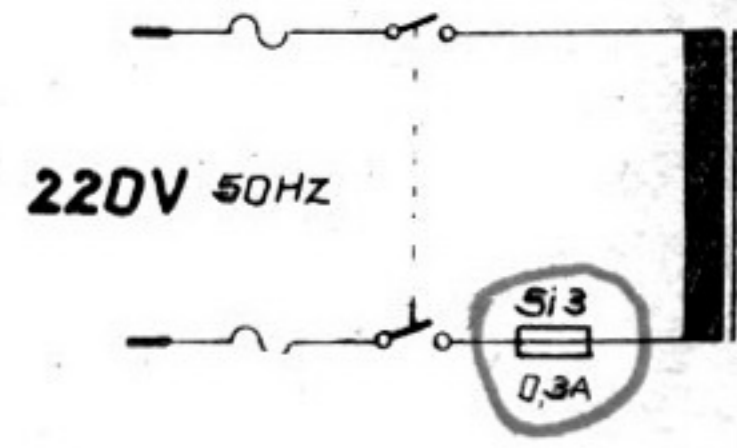
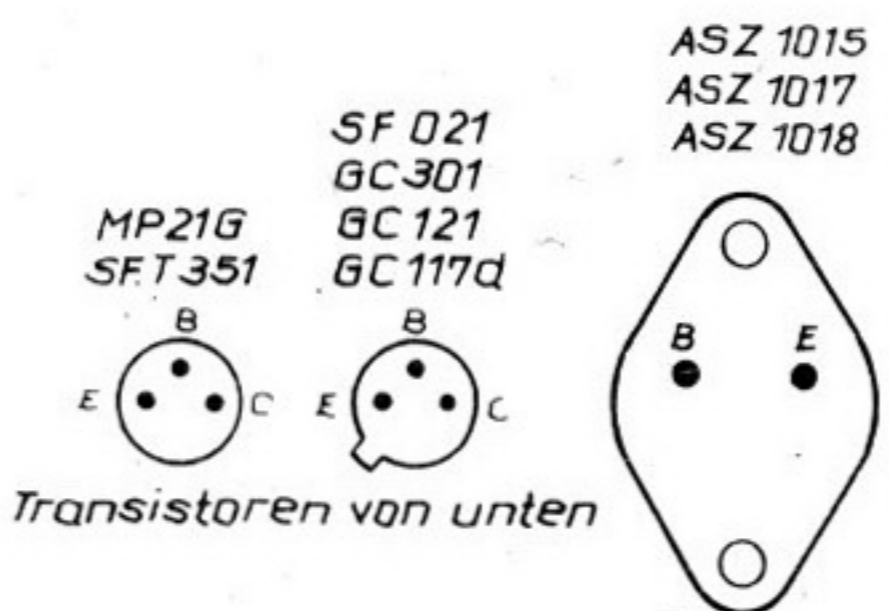

ab Ser. Nr. 01 sind  
 anstelle SF T 351  
 MP 21G eingesetzt  
 (Änderung B)

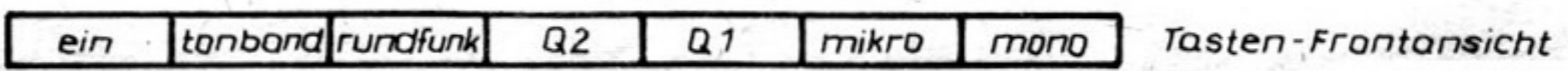

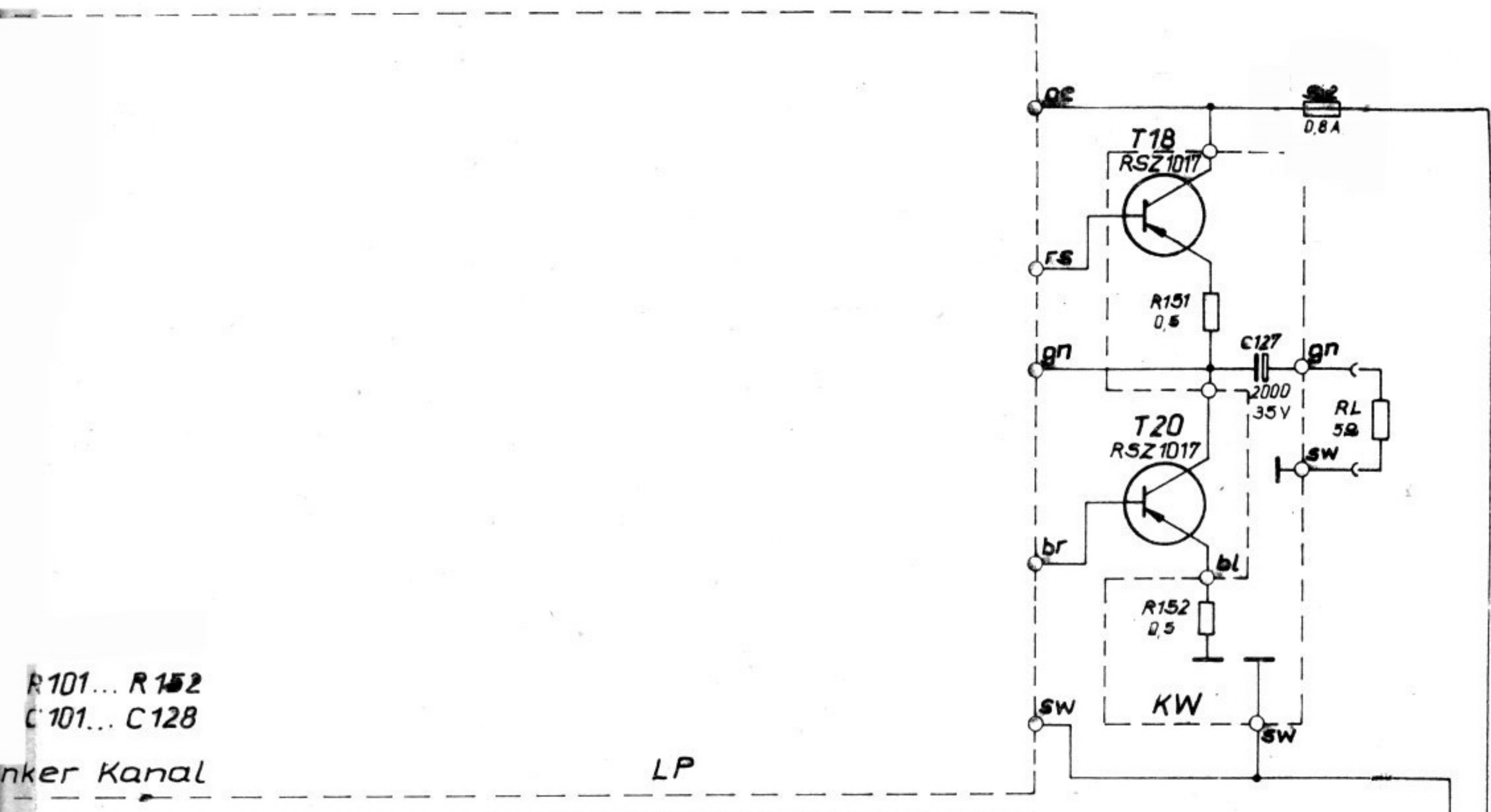

R101... R152  
C101... C128

Hörsender Kanal

LP

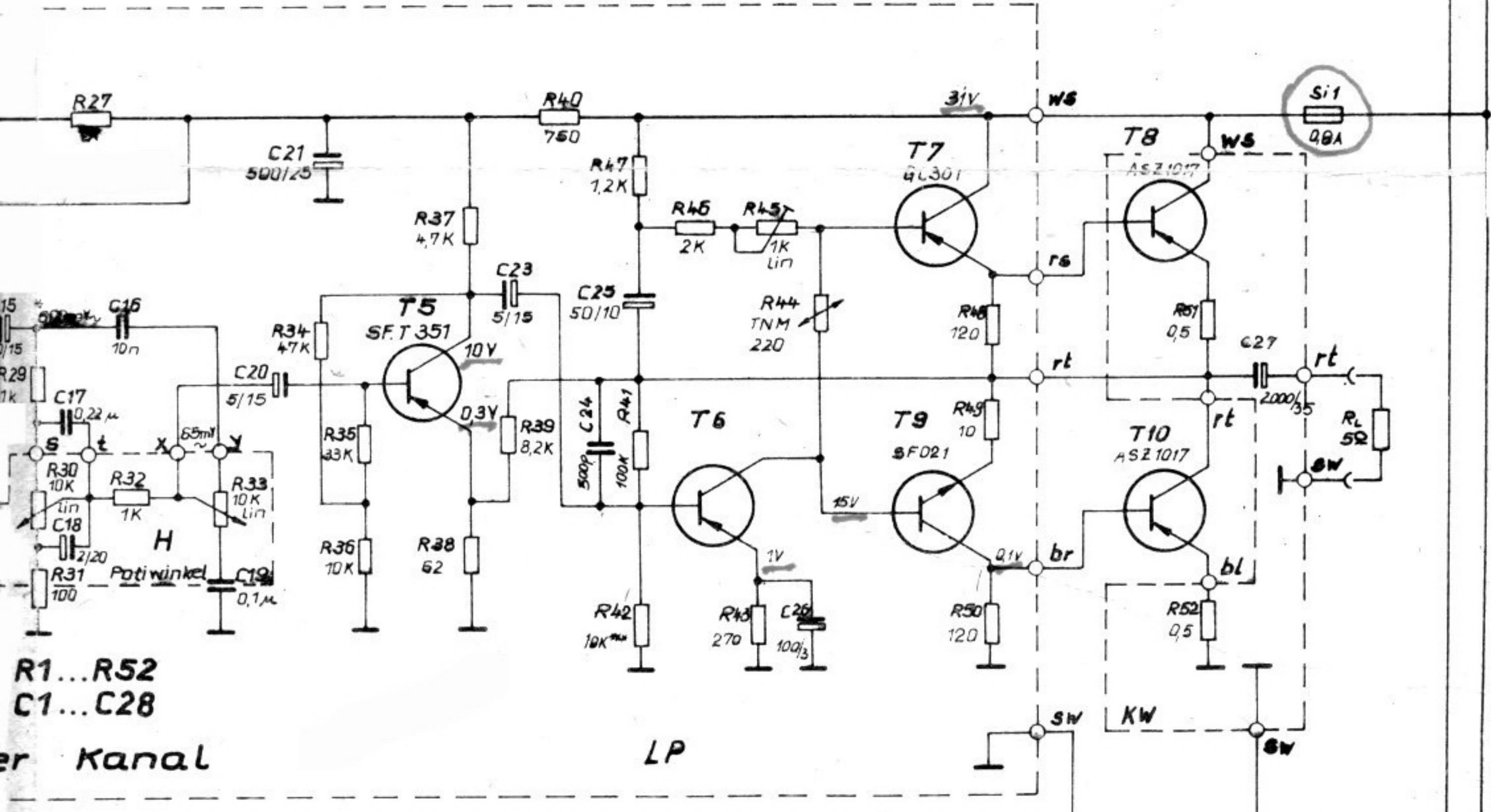

R1...R52  
C1...C28

Empfänger Kanal

LP

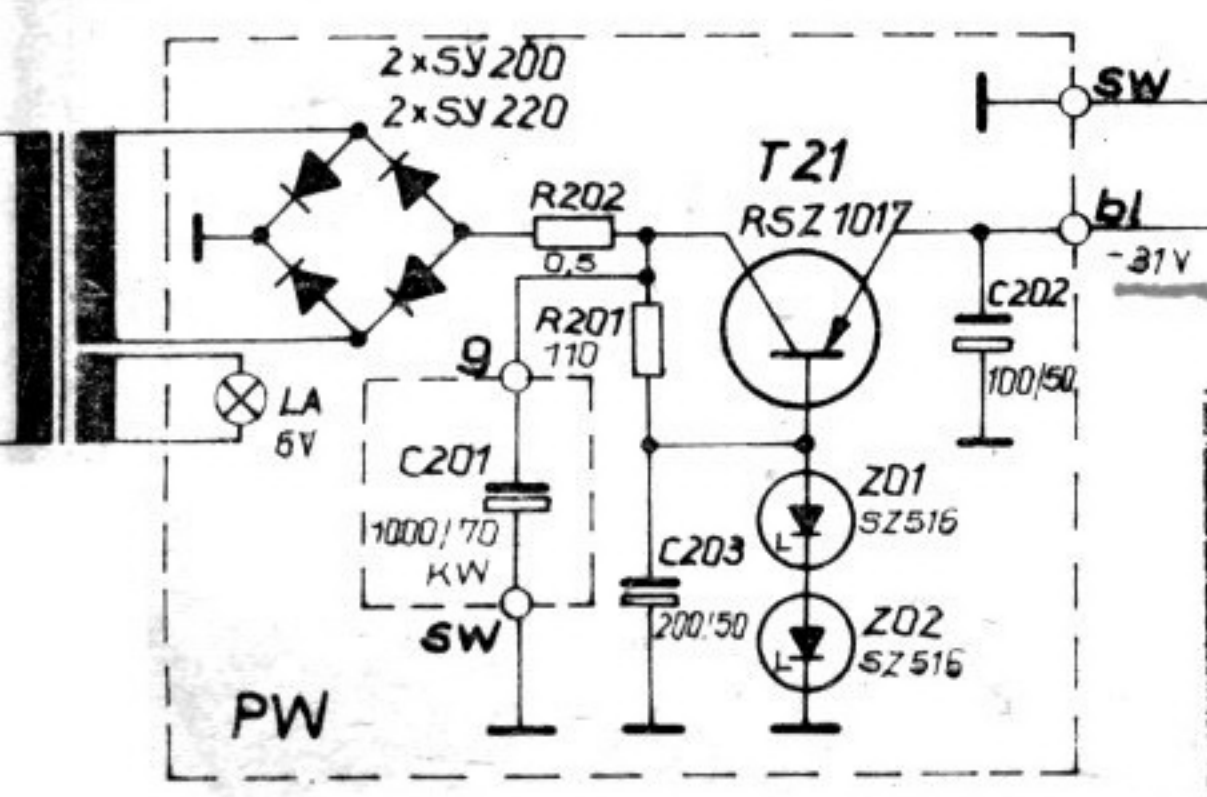

PW

Abbildung		Name	
1970	Tec	306 Höpfer	
C Neues Orig		PGH	
B ab Jan 70	15.2.1970 Wieland	Fernseh-Radio	
A	3.12.69 Wieland	Berlin	
Zus. Angabe		Stereostar I	
Schaltbild		187 - 1.0	